



# RIVAL ANGLED WALL PAD

## INSTALLATION INSTRUCTIONS

---

### WARNING:

This product is NOT suitable for installation on walls with metal studs.

Please follow the installation instructions carefully. Incorrect mounting may result in personal injury and/or damaged walls.

Before hitting the wall pad with full force, assess the firmness of the foam using gentle punches in order to avoid injury.

### Need help?

If you have any questions regarding the installation of this product, please contact the Rival Boxing Gear office closest to you.

**Canada:** 1-877-867-4825 / [customerservice@rivalboxing.com](mailto:customerservice@rivalboxing.com)

**United States:** 1-844-998-2269 / [usacustomerservice@rivalboxing.com](mailto:usacustomerservice@rivalboxing.com)

**United Kingdom:** +44 (0) 1327 310200 / [ukcustomerservice@rivalboxing.com](mailto:ukcustomerservice@rivalboxing.com)

**Australia:** +61 498 063 113 / [aucustomerservice@rivalboxing.com](mailto:aucustomerservice@rivalboxing.com)

---

## OPTION 1 (Recommended):

### CONCRETE WALL

Using the Included Hardware

### TOOLS REQUIRED:

- Power drill
- 3/16" (0.5cm), 1/4" (0.64cm), 5/8" (1.6cm) drill bits
- Socket ratchet set
- Laser level
- Measuring tape
- Masking tape
- Pencil or marker
- Hammer
- Safety goggles

1. Selecting a Mounting Spot:

- Make sure that the mounting location offers full-depth cement into which you can drill without damaging any structural elements of the building.
- The height at which you mount the wall pad should correspond to the height of the person (or average height of the people) who will be using it.
- To select the appropriate mounting height, make sure that the target patch on the top-center of the wall pad is aligned with your chin once the wall pad is mounted.

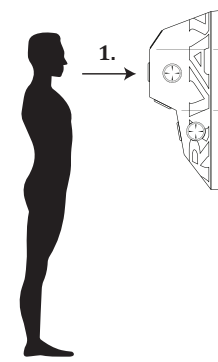

2. Hold the pad up to the wall on the desired mounting spot and mark the location of the top hole with a pen or a marker.

3. Using a drill with a 3/16" (0.5cm) or 1/4" (0.64cm) bit designed for use on concrete, begin making a hole in the wall where the mark is, making sure that the hole is 1/4" (0.64cm) deeper than the anchor you will be using. Use the "tape method" to gauge how deep to drill. Then finish the hole with the 5/8" (1.6cm) bit (starting with a smaller bit helps to reduce strain on your equipment.)

**Tape Method**  
(Click on the link for more details)

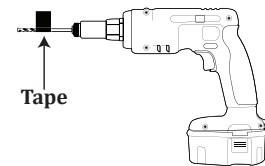

4. Insert an anchor (with nut, bolt and washer attached) into the hole by tapping it in with a hammer, being careful not to damage the anchor in the process.

5. Line up a laser level to the center anchor.

6. Place the wall pad onto the center anchor and secure it in place with the washer and nut by loosely hand-tightening the nut (you will need to remove it later).

7. Make sure the wall pad is in the desired position vertically with the help of the laser line, then mark the other 7 holes.

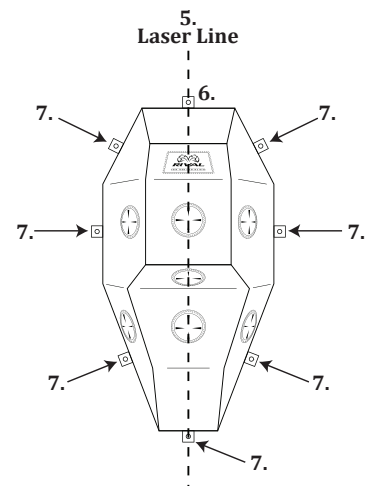

8. Remove the wall pad from the wall and repeat steps 3 and 4 for the other 7 anchors. Take your time and be very precise when drilling the holes to ensure that the wall pad frame will fit properly onto the anchors.

9. Once all the anchors are in the wall, hold the pad up in place and add the nuts, loosely securing each one by hand. Begin tightening each one equally, little by little, until all are fully hand-tightened.

Make sure to use a washer on each hole to ensure the long-term durability of your installation.

10. Finish up using a socket ratchet or an impact drill to fully tighten all the nuts, and make sure the anchors are properly expanded in the wall.
11. Tidy up and have fun with your new Rival Angled Wall Pad!

## Option 2

### Cinder Block Wall + Sheet of Plywood (3/4" (1.9cm) thick, 24" (61cm) wide, 48" (122cm) high)

Using the Included Anchors (4-6) and Lag Screws (not included)

#### TOOLS REQUIRED:

- Power drill
- 3/16" (0.5cm), 1/4" (0.64cm), 5/8" (1.6cm) drill bits
- Socket ratchet set
- Laser level
- Measuring tape
- Masking tape
- Pencil or marker
- Hammer
- Safety goggles

#### 1. Selecting a Mounting Spot:

- Select a mounting spot on the wall, making sure that the cinder blocks are not damaged in any way for at least 6 feet (1.83m) of space to the left and to the right of the installation spot.
- The height at which you mount the wall pad should correspond to the height of the person (or average height of the people who will be using it).
- To select the appropriate mounting height, make sure that the target patch on the top-center of the wall pad is aligned with your chin once the wall pad is mounted.

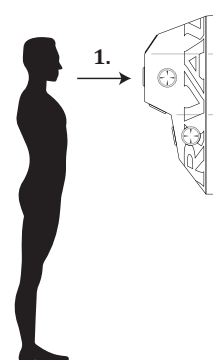

2. Hold the pad up to the wall on the desired mounting spot, making sure that the top hole of the frame is backed by a solid area of the cinder blocks (refer to the cinder block diagram) and NOT located on any of the joints between the blocks. Mark the location of the top hole with a pencil or a marker.

Dark area indicates solid area of the cinder block

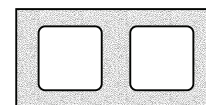

← Top View



← Front View



← Front View

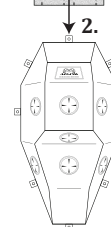

3. On your plywood, locate the center of the 24" (61cm) side by measuring 12" (122cm) from the edge and mark this point using a pencil or marker.

4. Now make another mark on the face of the plywood approximately 6" (15.24cm) down from this center point.

5. Using a drill with a 3/16" (0.5cm) or 1/4" (0.64cm) bit designed for use on concrete, begin making a hole in the wall where the mark is, making sure that the hole is 1/4" (0.64cm) deeper than the anchor you will be using.

Use the ["tape method"](#) to gauge how deep to drill.

Then, widen the hole with the 5/8" (1.6cm) bit (starting with a smaller bit helps to reduce strain on your equipment.)

6. Insert an anchor into the hole by tapping it in with a hammer, being careful not to damage the anchor in the process.

7. Using a 5/8" (1.6cm) bit designed for use on wood, make a hole in the plywood on the mark that is 6" down from the center point.

8. Using this new hole, hang the plywood onto the anchor which was previously inserted into the wall.

Then, line up a laser level with the mark at the centre point of the plywood to ensure that the final mounting will be level.

9. Holding the plywood in place to make sure it remains aligned with the laser line, mark the 4 corners of the plywood, ensuring that each corner is backed by a solid area of the cinder blocks.

10. Still holding the plywood in place, and using a 1/4" (0.64cm) bit designed for use on concrete, drill into the plywood on all four corner marks, making sure that your drill remains perpendicular to the wall at all times.

11. Once you've passed through the plywood and have marked the cinder blocks with the drill, remove the plywood from the wall.

Now, finish making the four holes in the wall where the marks are, making sure that the holes are 1/4" (0.64cm) deeper than the anchors you will be using.

Use the ["tape method"](#) to gauge how deep to drill.

Then, widen the holes with a 5/8" (1.6cm) bit designed for use on concrete.

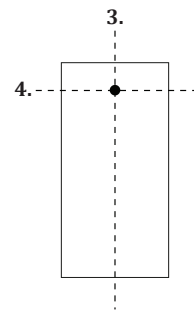

**Tape Method**  
(Click on the link for more details)

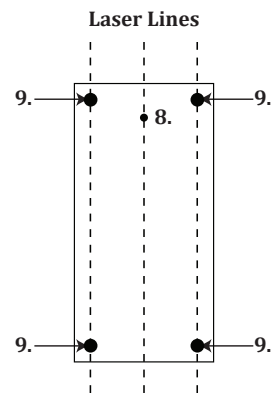
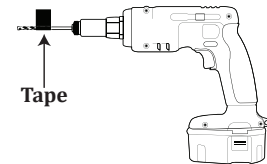

12. Insert an anchor into each hole by tapping them in with a hammer, being careful not to damage the anchor in the process.
13. Secure the plywood onto the wall using these four corner anchors with a nut, bolt and washer on each, and use a socket ratchet or an impact drill to fully tighten them.
14. Hang the wall pad onto the central anchor of the plywood using the top hole of the frame. Now, add a bolt and washer and loosely hand tighten the nut.
15. Using a laser level, make sure that the wall pad is vertically centered with the plywood.
16. Using lag screws, secure all of the other holes of the wall pad frame, loosely securing each one by hand. Make sure to use a washer on each hole to ensure the long-term durability of your installation.
17. Once all the lag screws are in place, begin tightening the nut on the top hole of the wall pad frame and each lag screw equally, little by little, until all are fully hand-tightened. Finish up using a socket ratchet or an impact drill to fully tighten them
18. Tidy up and have fun with your new Rival Angled Wall Pad!

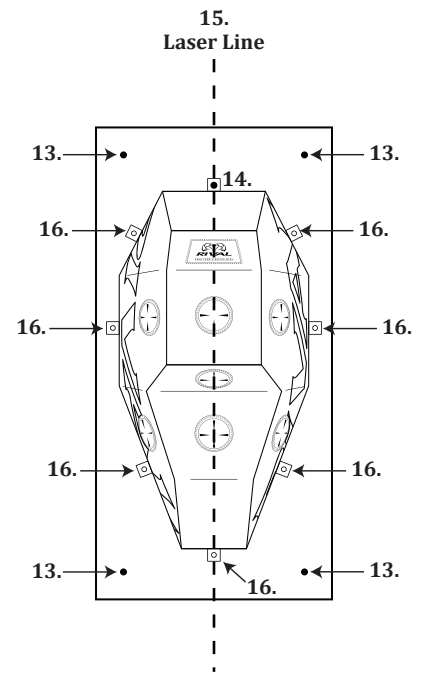

## Option 3

### Drywall With Wooden Studs + Sheet of Plywood (3/4" (1.9cm) thick, 36" (91.44cm) wide, 48" (122cm) high)

Using 3.5" (8.9cm) Wood Screws / Lag Screws (not included)

#### TOOLS REQUIRED:

- Power drill
- 3/16" (0.5cm), 1/4" (0.64cm), 5/8" (1.6cm) drill bits
- Socket ratchet set
- Laser level
- Stud finder
- Measuring tape
- Masking tape
- Pencil or marker
- Hammer
- Safety goggles

1. Selecting a Mounting Spot:

- Use a stud finder to locate a wooden stud and mark its center. This is where the top-center hole of the wall pad frame will be placed.
- The height at which you mount the wall pad should correspond to the height of the person (or average height of the people) who will be using it.
- To select the appropriate mounting height, make sure that the target patch on the top-center of the wall pad is aligned with your chin once the wall pad is mounted.

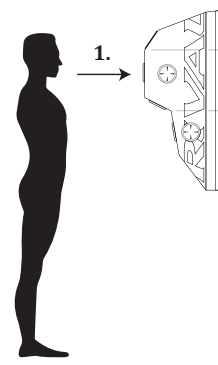

2. Make sure that the center of the studs directly to the left and to the right of your mark are each 16" (40.6cm) away from the mark. Now, mark the centres of those two studs as well.

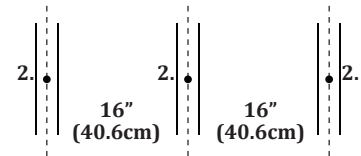

3. On your plywood, locate the center of the 36" (91.44cm) side by measuring 18" (45.7cm) from the edge and make a vertical line down the center of the plywood using a pencil or marker.

4. Line up a laser level with the center mark you made on the wall.

5. Hold the plywood up to the wall, aligning the vertical mark on plywood with the laser line. Starting approximately 2" (5.1cm) from the top-center of the plywood, insert a 3.5" (8.9cm) wood screw every 6 inches (15.24cm) along the laser line.

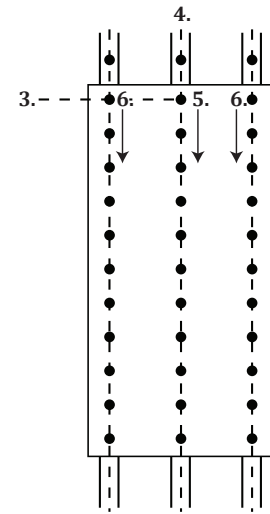

6. Do the same for the left and right studs, making sure that the screws are indeed going through the studs and not just the drywall.

7. Now that the plywood is secured onto all 3 studs of the wall, it's time to mount the wall pad onto the plywood.

8. Line up the laser level to the center mark once again.

9. Hold the pad up to the wall at the desired height and mark the location of the top hole with a pen or a marker.

Now, remove the pad from the wall and insert a screw into this new mark without tightening it all the way.

10. Hang the wall pad onto the central screw using the top hole of the frame.

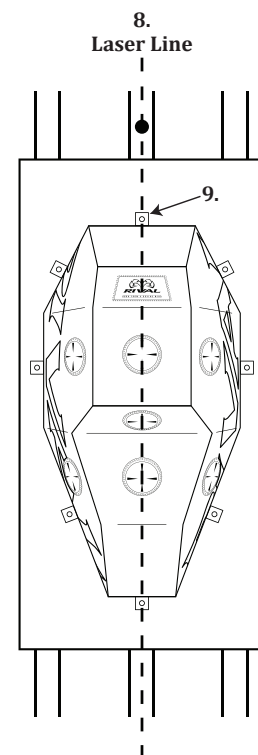

11. Using lag screws, secure all of the other holes of the wall pad frame, loosely securing each one by hand. Make sure to use a washer on each hole to ensure the long-term durability of your installation.

12. Once all the lag screws are in place, begin tightening each lag screw equally, little by little, until all are fully hand-tightened. Finish up using a socket ratchet or an impact drill to fully tighten them.

13. Tidy up and have fun with your new Rival Angled Wall Pad!

